

Syncrowave® 300

TIG/Stick Welding Power Source 

Quick Specs



Industrial Applications

Precision metal fabrication
Maintenance and repair
Light and heavy manufacturing
Shipbuilding
Tube and pipe
Automotive
Vocational

Processes

TIG (GTAW)
Stick (SMAW)
DC pulsed TIG (GTAW-P)

Input Power

208/240/480 V,
3-phase or 1-phase power

Amperage Range 5–300 A

Max. Open-Circuit Voltage 60 VDC

Rated Output 300 A at 22 V, 30% duty cycle
210 A at 18 V, 60% duty cycle

Net Weight

Machine only: 101 lb. (45.8 kg)
With Cooler and Running Gear: 176.4 lb. (80 kg)

Auto-Link® circuit automatically links the power source to primary voltage being applied (208/240/480 V, three- or single-phase).

Simple to install. Accepts either single- or three-phase input power.

Small footprint and lightweight design make it easy to install and maneuver.

Easy to use. Intuitive user interface is simple to understand making it easy to adjust parameters, and means less time training new employees and more time getting work done.

Pro-Set™ eliminates the guesswork when setting weld parameters.

Energy efficient. Save up to 33 percent on energy costs versus outdated welding equipment.

Line voltage compensation keeps power source constant regardless of fluctuations in input power (± 10 percent).

Arc timer/cycle counter records actual welding time and number of arc starts. Great for estimating job costs.

Wind Tunnel Technology™ protects internal electrical components from airborne contaminants, extending the product life.

Fan-On-Demand™ power source cooling system operates only when needed, reducing noise, energy use and the amount of contaminants pulled through the machine.

Blue Lightning™ provides more consistent high-frequency (HF) arc starts and greater reliability compared to traditional arc starters.

Lift-Arc™ provides AC or DC arc initiation without the use of high frequency.



Machine only

Complete package

More stable arc and better arc starts versus outdated welding equipment.

AC squarewave welding current automatically removes the layer of oxide that forms when welding on aluminum, helping to produce high-quality welds.

Auto-postflow adjusts the length of postflow time based on the amperage setting, shielding your tungsten and eliminating the need to set the postflow time.

Easy-load cylinder rack minimizes cylinder lifting. Cylinder is not included.

Internal cooler power supply runs the Coolmate™ 3S off of the input power and requires no additional hook up.

Coolmate™ 3S cooler (Complete packages only). Three-gallon cooling system features a flow indicator to visually indicate system is working and an external filter to stop objects from entering the water-cooled torch cable for better flow and longer life. Extended cooling capacity ensures maximum productivity. One-year cooler warranty.



Power source is warranted for three years, parts and labor.



Miller Electric Mfg. LLC
An ITW Welding Company
1635 West Spencer Street
P.O. Box 1079
Appleton, WI 54912-1079 USA

Equipment Sales US and Canada
Phone: 866-931-9730
FAX: 800-637-2315
International Phone: 920-735-4554
International FAX: 920-735-4125

MillerWelds.com



Weld Process Features

AC TIG

Balance control provides adjustable oxide removal which is essential for creating the highest quality aluminum welds.

Frequency controls the width of the arc cone and can improve directional control of the arc.

DC TIG

Exceptionally smooth and precise arc for welding exotic materials.

Pulse. Pulsing can increase puddle agitation, arc stability and travel speeds while reducing heat input and distortion.

DC Stick

DIG control allows the arc characteristics to be changed for specific applications and electrodes. Lower the DIG setting for smooth running electrodes like E7018 and increase the DIG setting for stiffer, more penetrating electrodes like E6010.

Hot Start™ adaptive control provides positive arc starts without sticking.

AC Output: Balance and Frequency Control

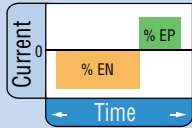
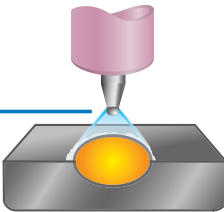
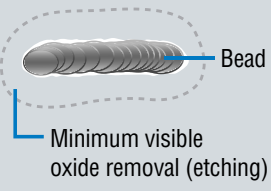
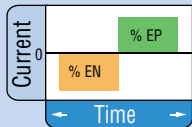
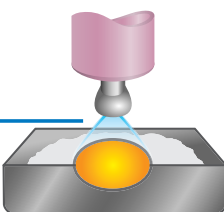
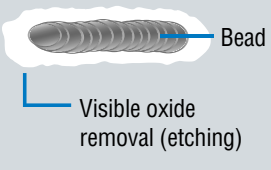
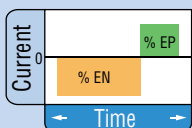
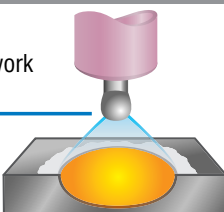
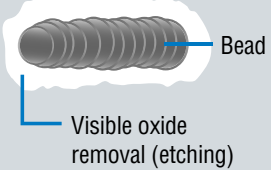
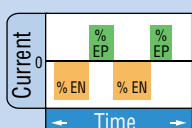
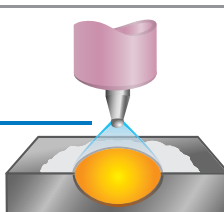
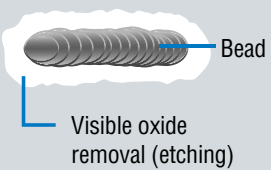
Feature	Setting	Arc Effect	Weld Effect
AC Balance Control Controls arc cleaning action. Adjusting the % EN of the AC wave controls the width of the etching zone surrounding the weld. <i>Note: Set the AC Balance control for adequate arc cleaning (etching) action at the sides and in front of the weld puddle. AC Balance should be fine-tuned according to the amount of etching desired.</i> Balance range: Ball, 60–80% Pro-Set™ setting: 68%	75% EN 	Reduces balling action and helps maintain point 	
	50% EN 	Increases balling action of the electrode 	
AC Frequency Control Controls the width of the arc cone. Increasing the AC Frequency provides a more focused arc and increased directional control. <i>Note: Decreasing the AC Frequency softens the arc and broadens the weld puddle for a wider weld.</i> Frequency range: 50–150 Hz Pro-Set™ setting: 70 Hz	60 Hz 	Wider profile ideal for buildup work 	
	120 Hz 	Narrower profile for fillet welds and automated applications 	

Specifications (Subject to change without notice.)



Welding Process	Input Power	Welding Amperage Range	Rated Output	Amps Input at Rated Load Output, 50/60 Hz					Max. Open-Circuit Voltage	Dimensions	Net Weight
				208 V	240 V	480 V	KVA	KW			
TIG* (GTAW)	3-phase	5-300 A	300 A at 22 V, 30% duty cycle	27	23	11	9.7	9.2	60 VDC (13 VDC**)	Power Source H: 29.4 in. (746 mm) W: 15 in. (381 mm) D: 24.6 in. (625 mm) With Cooler and Running Gear H: 43.9 in. (1114 mm) W: 20.5 in. (521 mm) D: 36.3 in. (921 mm)	Power Source 101 lb. (45.8 kg) With Cooler and Running Gear 176.4 lb. (80 kg)
	1-phase			47	41	19	9.7	9.4			
	3-phase	5-300 A	210 A at 18.4 V, 60% duty cycle	16	14	7	5.9	5.5			
	1-phase			27	24	12	5.7	5.5			
	3-phase	5-300 A	175 A at 17 V, 100% duty cycle	13	11	6	4.8	4.3			
	1-phase			13	11	6	4.8	4.3			
Stick (SMAW)	3-phase	5-230 A	230 A at 28.4 V, 30% duty cycle	25	22	11	8.9	8.6	60 VDC (13 VDC**)		
	1-phase			44	37	18	9	8.8			
	3-phase	5-230 A	160 A at 26.4 V, 60% duty cycle	16	11	5	5.7	5.5			
	1-phase			27	23	11	5.7	5.5			
	3-phase	5-230 A	125 A at 25 V, 100% duty cycle	12	10	5	4.3	4.2			
	1-phase			20	18	9	4.2	4.1			

*Includes cooler power draw. **Sense voltage for low OCV stick and Lift-Arc™ TIG.

Certified by Canadian Standards Association to both the Canadian and U.S. Standards.

Performance Data

Duty Cycle Chart

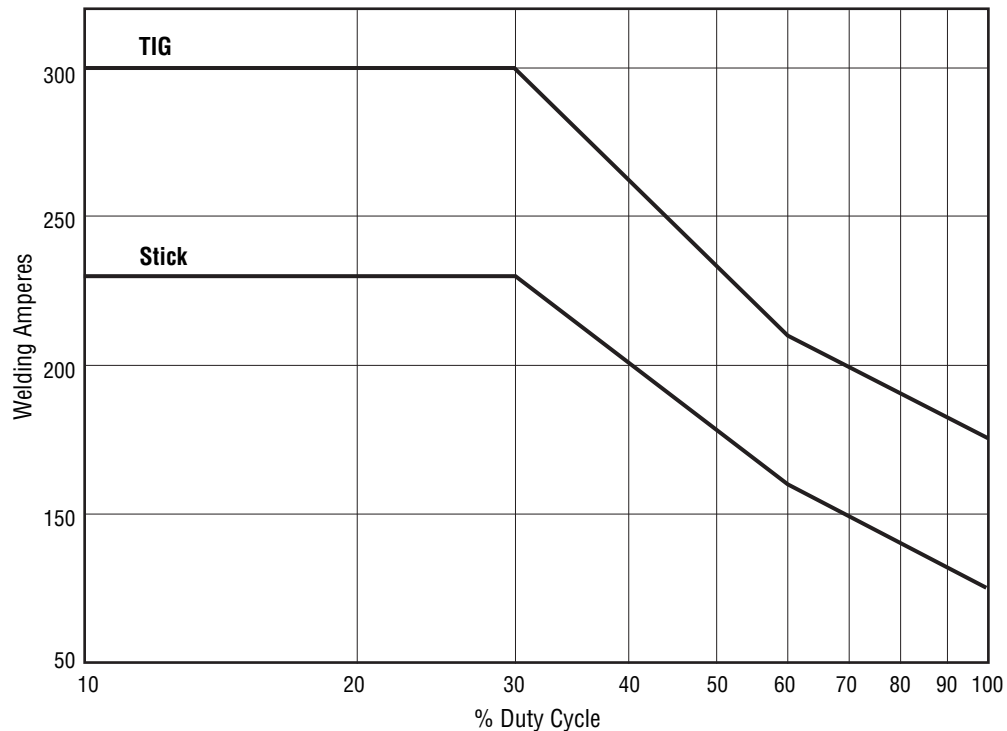

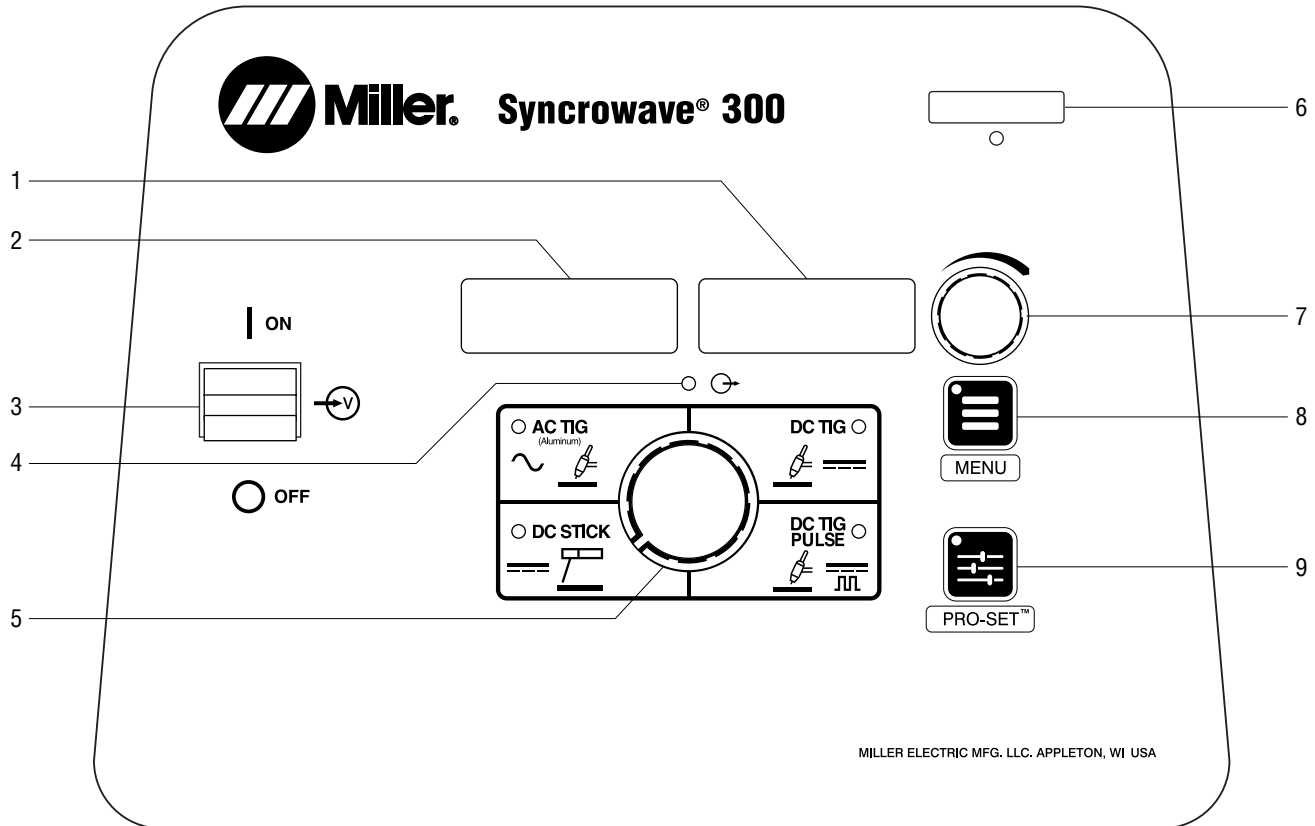

MILLER ELECTRIC MFG. LLC. APPLETON, WI USA

1. Ammeter

Displays actual amperage while welding and preset amperage while idle. It is also used to display parameter selection options while in the menu.

2. Voltmeter

Displays actual rectified average voltage when voltage is present at the weld output terminals. It is also used to display parameter descriptions while in the menu.

3. Main Power Switch

Use switch to turn machine on or off.

4. Output ON Indicator

Blue indicator illuminates when output is on.

5. Process Selector

AC TIG — Used for welding aluminum.

DC TIG (DCEN) — Used for welding mild and stainless steel.

DC TIG Pulse (DCEN) — Used for welding mild and stainless steel.

DC Stick (DCEP) — Used for welding steels.

6. Memory Card Port and Indicator

This port is used to add features to the machine and update software to the boards within the machine. Indicator is lit while card is being accessed.

7. Amperage Adjustment Control

Use control to change preset amperage value. If a remote control is used, preset amperage value is the maximum amperage output available. This control also functions as a parameter change control while in the menu mode.

8. Menu Button

Press button to scroll through available parameters for the selected process. Hold button to enter setup mode.

9. Pro-Set™ Button

Press button to lock in all parameters to factory settings while LED is lit. Press and hold for five seconds to reset all parameters to factory settings. Meter display counts down.

Syncrowave® 300 Models/Packages

Machine only



Syncrowave 300 machine only

907782 (208/240/480 V)

Input power plug NOT included.

TIGRunner®



Syncrowave 300 TIGRunner package

907782001 (208/240/480 V)

Completely assembled. Includes Syncrowave, Coolmate™ 3S cooler, and running gear.

Input power plug NOT included.

Syncrowave 300 Complete Package with wired foot control shown.



Syncrowave 300 Complete packages

951000003 (208/240/480 V) with wired foot control

951872 (208/240/480 V) with wireless foot control

Completely assembled. Includes Syncrowave, Coolmate™ 3S cooler, running gear, RFCS-14 HD remote foot control **OR** wireless remote foot control, four gallons of TIG coolant, and a water-cooled torch kit consisting of Weldcraft™ W-280 TIG torch, AK4GL gas lens torch accessory kit, cable cover, flowmeter regulator, gas hose, torch connector, and work clamp with cable and Dinse-style connector.

Input power plug NOT included.

Genuine Miller® Accessories

Running Gear/Cylinder Rack



Syncrowave 300/400 4-Wheel Cart 301601
For Syncrowave 300/400 (machine only). Cart includes storage space with latching door, handles, cylinder rack with chain, foot control holster, and cooler adapter kit. Allows for the addition of a Coolmate™ 3 externally powered cooler if desired.

TIG Torch Kits and Connectors



W-280 Water-Cooled Torch Kit 300990
Kit comes with Weldcraft™ W-280 (WP-280) 25-foot (7.6 m) TIG torch with Dinse-style connector, torch cable cover, work clamp with 15-foot (4.6 m) cable and Dinse-style connector, flowmeter regulator with gas hose and AK4GL gas lens torch accessory kit.

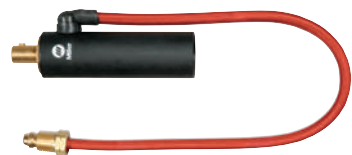

Water-Cooled TIG Torch Connector 195377
50 mm Dinse-style with water return line. For use with all Weldcraft™ water-cooled torches.



Air-Cooled TIG Torch Connector 195379
Used to adapt a Weldcraft™ A-200 (WP-26) torch to a Dinse-style connector.

Remote Controls and Switches



Wireless Remote Foot Control 301580
For remote current and contactor control. Receiver plugs directly into the 14-pin receptacle of Miller machine. 90-foot (27.4 m) operating range.



Wireless Remote Hand Control 301582
For remote current and contactor control. Receiver plugs directly into the 14-pin receptacle of Miller machine. 300-foot (91.4 m) operating range.



RFCS-14 HD Foot Control 301589
Heavy-duty foot pedal current and contactor control provides increased stability and durability from larger base and heavier cord. Includes 20-foot (6 m) cord with plug.



RHC-14 Hand Control 242211020
Miniature hand control for remote current and contactor control. Dimensions: 4 x 4 x 3.25 inches (102 x 102 x 83 mm). Includes 20-foot (6 m) cord and 14-pin plug.



RCCS-14 Remote Contactor and Current Control 043688
North/south rotary-motion fingertip control attaches to TIG torch using two hook-and-loop fasteners. Includes 26.5-foot (8 m) cord and 14-pin plug.



RCC-14 Remote Contactor and Current Control 151086
East/west rotary-motion fingertip control attaches to TIG torch using two hook-and-loop fasteners. Includes 26.5-foot (8 m) cord and 14-pin plug.



RMLS-14 Switch 129337
Momentary- and maintained-contact rocker switch for contactor control. Push forward for maintained contact and backward for momentary contact. Includes 26.5-foot (8 m) cord and 14-pin plug.



RMS-14 On/Off Control 187208
Momentary-contact switch for contactor control. Rubber-covered pushbutton dome switch ideal for repetitive on-off applications. Includes 26.5-foot (8 m) cord and 14-pin plug.

Extension Cables for 14-Pin Remote Controls
242208025 25 ft. (7.6 m)
242208050 50 ft. (15.2 m)
242208080 80 ft. (24.4 m)

Genuine Miller® Accessories (continued)

Coolant



Low-Conductivity Coolant 043810

Must be ordered in quantities of four. One-gallon recyclable plastic bottle. Miller coolants contains a base of ethylene glycol and deionized water to protect against freezing to -37° Fahrenheit (-38°C) or boiling to 227° Fahrenheit (108°C).

TIG Welding Gloves



Performance TIG Gloves

263346 Small

263347 Medium

263348 Large

263349 X-Large

Completely unlined, goat grain leather with triple-padded palm.

Educational Materials

To order, please call Miller Literature at 866-931-9732 or visit MillerWelds.com/resources/tools.

Gas Tungsten Arc Welding (TIG) Publication 250833

Tungsten

Tungsten	Amp Range	2% Ceriated (AC/DC)	2% Lanthanated (AC/DC)
1/16 in. (1.6 mm)	70–150 A	WC116X7	WL2116X7
3/32 in. (2.4 mm)	140–250 A	WC332X7	WL2332X7
1/8 in. (3.2 mm)	225–400 A	WC018X7	WL2018X7
5/32 in. (4.0 mm)	300–500 A	WC532X7	WL2532X7

Ordering Information

Equipment and Options	Stock No.	Description	Qty.	Price
Syncrowave® 300	907782	Machine only. 208/240/480 V, 50/60 Hz		
Syncrowave® 300 TIGRunner®	907782001	208/240/480 V, 50/60 Hz		
Syncrowave® 300 Complete with Wired Foot Control	951000003	208/240/480 V, 50/60 Hz		
Syncrowave® 300 Complete with Wireless Foot Control	951872	208/240/480 V, 50/60 Hz		
Running Gear/Cylinder Rack				
Syncrowave 300/400 4-Wheel Cart	301601	For Syncrowave 300 and 400 with or without Coolmate 3		
TIG Torch Kits and Connectors				
W-280 Water-Cooled Torch Kit	300990	See page 6 for contents		
Water-Cooled TIG Torch Connector	195377	Connects Weldcraft™ water-cooled torches to Dinse-style connector		
Air-Cooled TIG Torch Connector	195379	Connects Weldcraft™ A-200 (WP-26) torch to Dinse-style connector		
Remote Controls				
Wireless Remote Foot Control	301580	Foot control with wireless 90 ft. (27.4 m) operating range		
Wireless Remote Hand Control	301582	Hand control with wireless 300 ft. (91.4 m) operating range		
RFCS-14 HD	301589	Heavy-duty foot control		
RHC-14	242211020	Hand control		
RCCS-14	043688	North/south fingertip control		
RCC-14	151086	East/west fingertip control		
RMLS-14	129337	Momentary/maintained rocker switch		
RMS-14	187208	Momentary rubber dome switch		
Extension Cables		See page 6		
Accessories				
TIG Coolant (must be ordered in quantities of four)	043810	1-gallon plastic bottle. Protects against freezing to -37° Fahrenheit (-38°C) or boiling to 227° Fahrenheit (108°C)		
TIG Welding Gloves		See page 7		
Gas Tungsten Arc Welding (TIG) Publication Tungsten	250833	See page 7		
Cable Connectors and Adapters				
Dinse-Style Connector 50 mm (1 male)	042418	Used to connect weld lead to Dinse terminal machine		
Dinse-Style Connector 50 mm (1 male, 1 female)	042419	Used to extend weld cables		
Dinse/Tweco® Adapter	042465	Male Dinse-style to female Tweco		
Dinse/Cam-Lok Adapter	042466	Male Dinse-style to female Cam-Lok		
Educational Materials				
		See page 7		

Date:

Total Quoted Price:

Distributed by:

